

Please read this user manual
before using the machine.

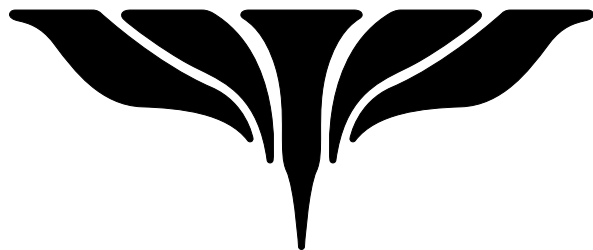

EL ROCIO
e s p r e s s o m a c h i n e

ZARRE.R

USER MANUAL

Dual Boiler
Stainless Steel



OPV



15BAR PUMP



Dual Gauge



1.2 pi / 3 Hole
Steam Tip



58mm
Group Head





EL ROCIO

espresso machine

1. About
2. Contents and included accessories
3. Precautions before using
4. How to use
5. Cleaning and maintenance
6. Instructions and FAQ
7. Controller user manual

Contents and included accessories

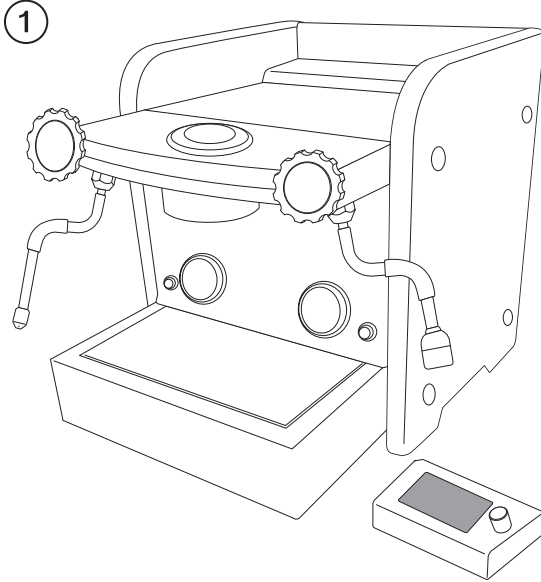

- ① Zarre R
- ② 2-spout portafilter
- ③ Cleaning brush
- ④ Blind basket
- ⑤ 7g basket
- ⑥ 14g basket

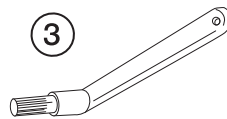
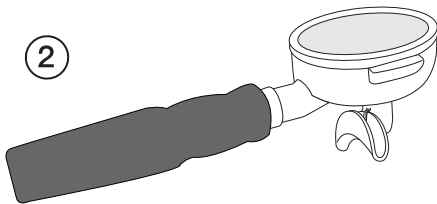

El Rocio

Contents and included accessories

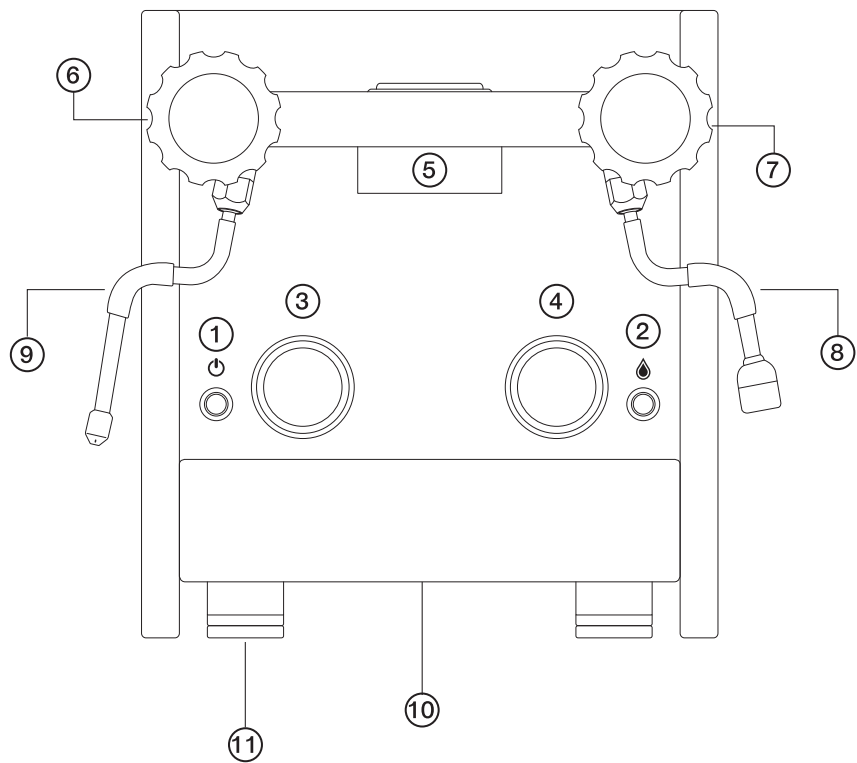

- ① Power switch
- ② Brew switch
- ③ Steam pressure gauge
- ④ Extraction pressure gauge
- ⑤ Group head
- ⑥ Steam knob
- ⑦ Hot water knob
- ⑧ Hot water wand
- ⑨ Steam wand
- ⑩ Drip tray
- ⑪ Level control feet

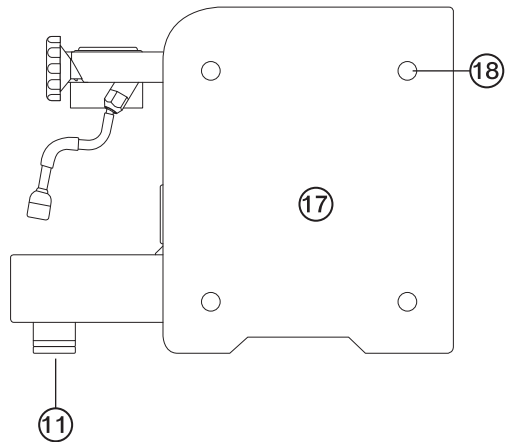
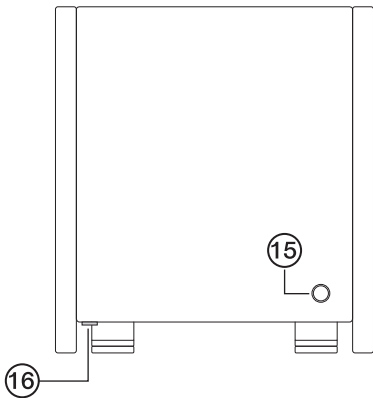
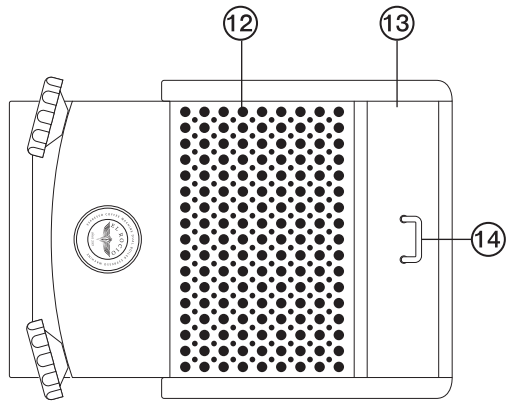

⑫ Cup warmer

⑬ Service tank cover

⑭ Service tank cover handle

⑮ Controller connection point

⑯ Main power switch

⑰ Side panel

⑱ Side panel fastening bolt

El Rocio

Precautions before using

Please read carefully before using.

We are not responsible for any safety incidents that arise from ignoring the safety precautions.



Warning

Please use the correct electric specification.

Ignoring the precautions may lead to physical injuries or damages.

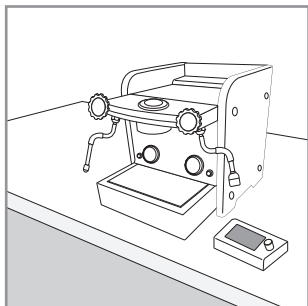

Warning

Heavy object warning

Product weight 35kg

- ✓ Please use caution when installing the machine and use the proper form.
- ✓ Install/use the machine on a solid surface.

 Burn hazard



- ✓ Before moving the machine, the service tank's water must be empty and the boiler must be fully cooled down.

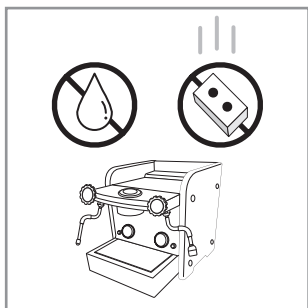

- ✓ Do not place liquids such as water or milk on the cup warmer, and keep falling objects away from the machine.
- ✓ Do not use a piece of cloth to cover the machine.
- ✓ Keep out of children's reach and make sure children do not use the machine.

Precautions before using

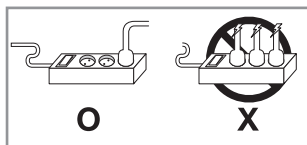

- ✓ When using a multi-tab power strip, a safety-approved unit must be used.
- ✓ using too many plugs at once can lead to a power overload fire
- ✓ Do not place sharp objects or liquids that can cause electrocution around the machine. (flammable, combustible liquids)
- ✓ Keep the machine away from heat sources or other electronics.
- ✓ The risk of electrocution exists when touching the machine with wet hands.

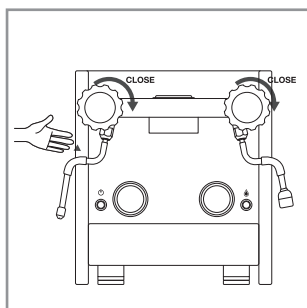

- ✓ Close the steam and hot water valve clockwise until completely closed before using.
 - ※ At first usage, keep the hot water knob open half turn counterclockwise. (This is to remove water from the hot water boiler.)
- ✓ Steam and hot water valves are burn hazards immediately after use when touched. Please use the rubber handle to hold.

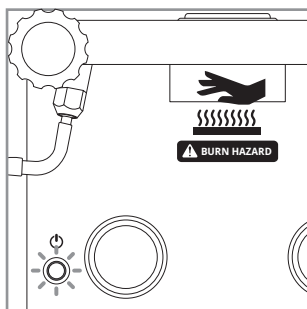

- ✓ Group head is extremely hot when on. Please avoid burn damage by not touching the group head.

 **burn hazard**



**Hot surfaces.
Do not touch.
Proceed with caution
when using.**

El Rocio

How to use

*For Zarre, you can check the status of the machine by checking the color of power and extraction light blinking.



No water in service tank

- ✓ **The power switch's red lamp blinks rapidly.**

check ✓ When refilling the service tank, make sure the service tank is removed from the machine.



Steam pump water level is coming up to spec

- ✓ **The power switch's red lamp blinks at a medium speed.**



Hot water supply pump is operating

- ✓ **The power switch's red lamp blinks at a slow speed**



The extraction switch's green lamp will blink until the hot water boiler is up to extraction-ready temperature

- ✓ **The machine is ready to extract when the extraction switch's green lamp stops blinking.**



When the steam boiler gauge pressure is at 1.5 bar before extraction

- ✓ **This is when the machine is ready for steaming.**

How to use

1. How to plumb-out drainage (optional)

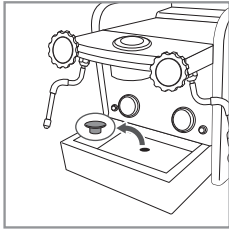

- 1) Separate the drip tray rubber seal.

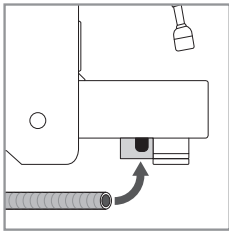

- 2) Connect the drain tube (1.4m) to the bottom structure of the drip tray

check

✓ Unless you are using automated draining, this installation is not necessary

2. How to plumb-in machine (optional)

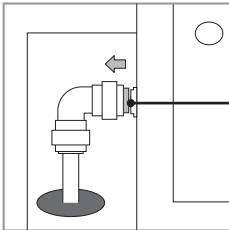

1. Water purifier hose (6.5mm) sold separately

check

How to plumb-in machine (optional)
Water purifier hose (6.5mm) sold separately

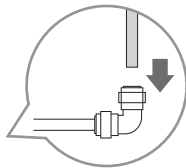
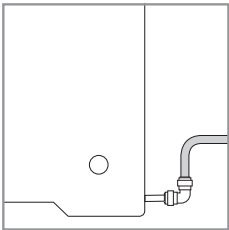

Extend the water purifier hose and connect to the fitting

Unless you're plumbing in the machine, this installation is not necessary.

How to use

Recommended single extraction time is maximum 60 seconds, and we recommend 2 minute rest time after every use.

※ 30 second extraction / 1 minute rest (based on 2 shot lungo, 80ml extraction)

1. water tank removal and cleaning

- ✓ Before connecting to power, remove water tank in order of the diagrams below and fill water tank with water.

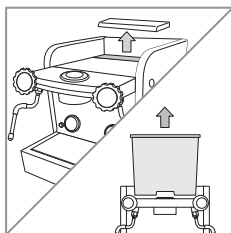

- 1) Open the external water tank cover and remove the water tank by pulling upwards.

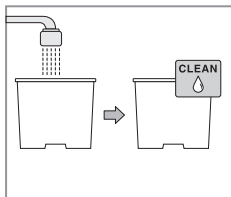

- 2) Clean water tank and remove outer moisture.

check

✓ We recommend drying after cleaning

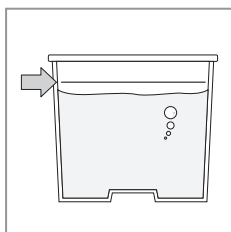

- 3) Before re-installing the water tank, fill water up to the guide line

How to use

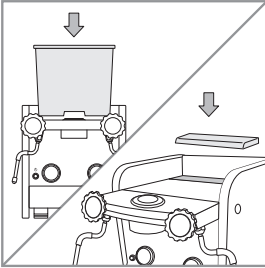

- 4) Place the water tank in the machine by grabbing the water tank with both hands.
- 5) Attach outer water tank case.

2. Connecting the machine power

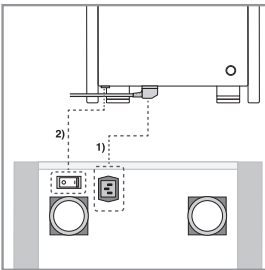

- 1) After checking precautions, connect machine side plug and connect power plug to the power supply.
- 2) Switch main power switch to the on position.

check

- ✓ Please read precautions and connect.
- ✓ Before turning the machine on, make sure the steam / hot water knobs are turned all the way clockwise in a locked position.

3. Turning on machine and preheating

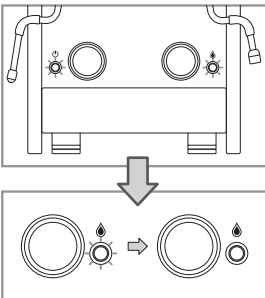

- 1) Power turns on when the power button on the front left side of the machine is pushed.
- 2) When turning the machine on for the first time, the pump will operate and the boiler will get filled up with water from the water tank.
- 3) When the right extraction button stops blinking and the steam boiler's pressure gauge reads 1.5 bar, all preheating steps are completed.

check

- ✓ Because the boiler requires a lot of water to get to normal operating conditions, please fill water up to the guide line in the service tank.

El Rocio

How to use

4. extraction

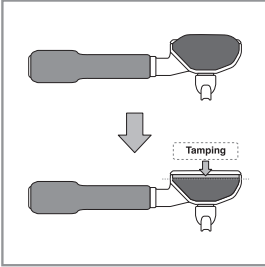

- 1) Dose an adequate amount of coffee into the portafilter basket, and tamp using a tamper.

check

- ✓ When tamping, make sure the portafilter is in a secure position and avoid wrist injuries by not applying excessive pressure.

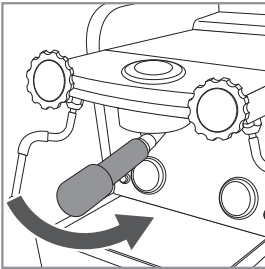

- 2) Lock in the portafilter from the 7 o'clock position to 6 o'clock position

A. When locking the portafilter in, ensure it is level. Both wings of the portafilter must be fully inside the group head before locking in.

b. Before locking the portafilter in, we recommend a 1-2 second flushing of the group by turning the brew group lever up.

check



✓ When locking in the portafilter, pay extra attention to the group head as it is a burn hazard.

✘ *brew water and group head temperature ranges from 85-99°C which are high temperatures

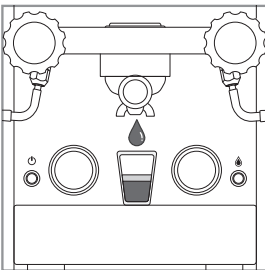

- 3) Begin extraction by pushing the extraction switch until desired amount is reached.

check

- ✓ Do not use hot water valve during extraction.
- ✓ Overly forced portafilter lock-in and removing the portafilter mid-extraction can cause damages to the machine and can cause bodily injuries from high temperature and high pressure.

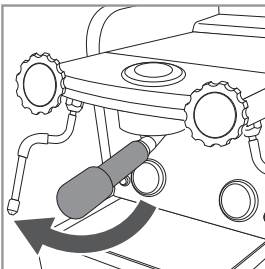

- 4) Remove portafilter after extraction is finished by turning the portafilter handle from 6 o'clock to 7 o'clock position.
- 5) Remove coffee puck from portafilter, wash portafilter, then wipe with dry cloth.

How to use

5. Using steam

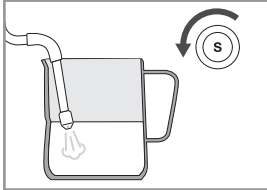

1) Place steam wand inside of a steam pitcher with milk inside, turn steam knob counter clockwise, begin steaming milk.

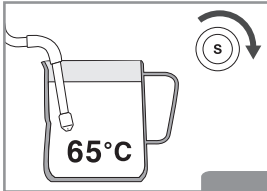

2) When milk reaches appropriate temperature, turn steam knob clockwise to completely locked position.



1. When steam wand makes direct contact with skin, it can become a
2. Please operate by holding the rubber handle of the steam wand.
3. When releasing condensate, please turn nozzle over to the drip tray and use wet towel to cover nozzle before releasing.
4. Directly touching steam that's being released is a burn hazard

6. Using hot water

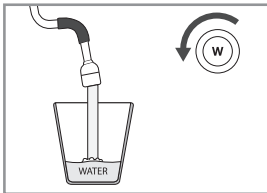

1) When hot water tap is turned half counterclockwise, hot water comes out.

2) When desired amount of hot water is reached, turn the hot water knob clockwise to lock.

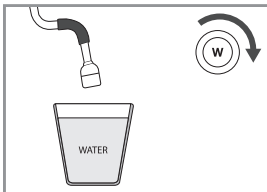

- ✓ When the hot water wand comes in direct contact with skin, it is a burn hazard.
- ✓ Please operate by holding the hot water wand's rubber handle.

※ Once finished using, push the machine power button to switch the machine off to avoid any secondary damages or burns while cleaning.

El Rocio

How to use

7. How to install and remove shower screen

1. Place the shower screen and gasket on top of the portafilter without the basket.

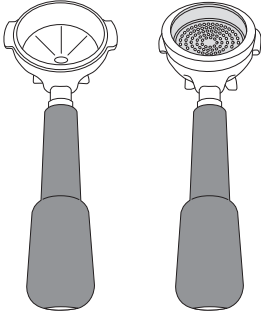

2. Take the prepared portafilter with shower screen and gasket, place into the group head and turn as far counterclockwise as the portafilter can go to install shower screen.

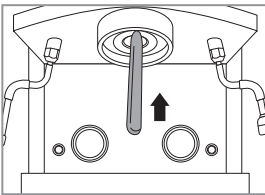
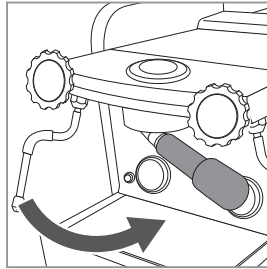
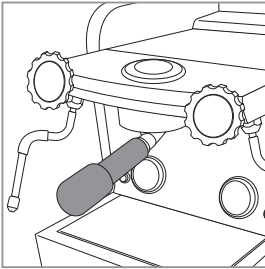

check

If the gasket does not go in well,
use a blunt tool to push it upward.

How to use

3. **Check for correct installation by placing a basket inside the portafilter and attaching the portafilter to the group head.**

※ When using a new gasket, the portafilter may not turn to its original fully locked position of 6'O clock."

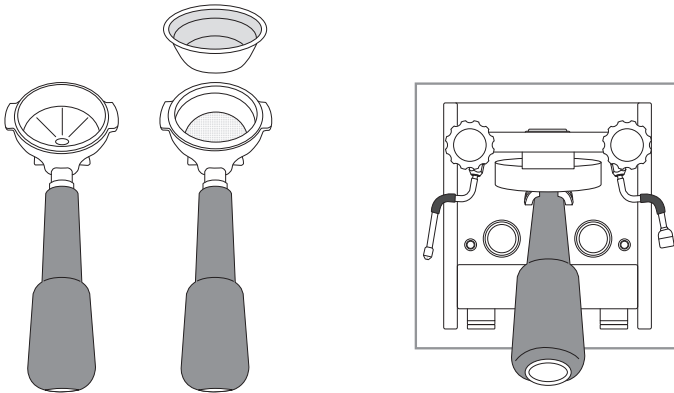

4. How to remove shower screen

※ Take a tool without a sharp end (tea spoon, etc) and pull down at the edge of the showerscreen.

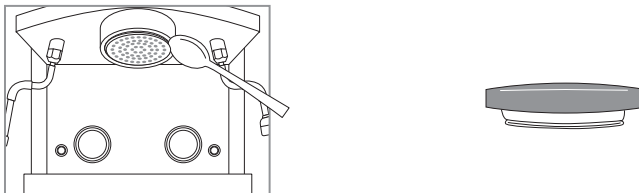

El Rocio

Cleaning and maintenance

- ※ Please ensure the machine is fully off and cooled down, with the main switch in the off position, prior to cleaning the machine.

1. Cleaning the group head

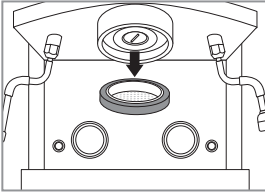

- 1) Remove the shower screen from group head as shown in the diagram. Use a tool to remove the shower screen and be careful not to scratch or damage the group head.

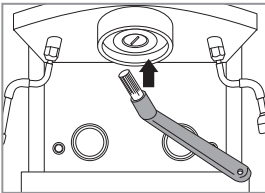

- 2) Clean with a cleaning brush.

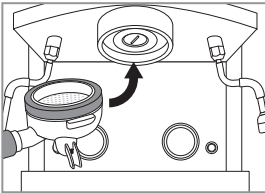

- 3) After cleaning, use the portafilter to re-install the shower screen.



check

✓ Do not use hand to remove shower screen from group head.

2. Steam / hot water wand cleaning

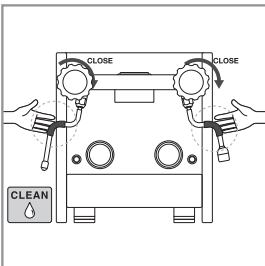

- 1) Clean and wipe while securing the steam / hot water wand by the rubber handle.



check

✓ Clean with the steam / hot water knob fully closed

Cleaning and maintenance

3. cleaning the water tank

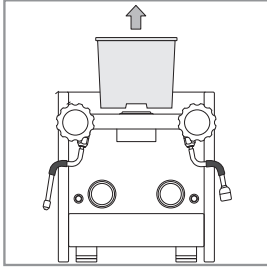

1)

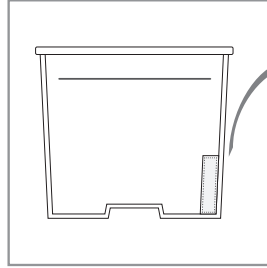

1) remove water tank from machine



The direction of the magnetic sensor located inside is with the black part facing down.

2) Separate the water tank and the low water float sensor when cleaning

3) When machine cleaning is finished, install in reverse order.

4. cleaning drip tray

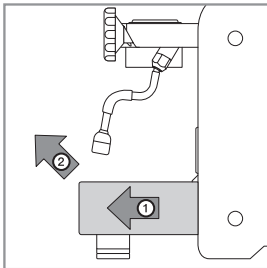

- 1) Take both hands to grip the ends of drip tray then slowly pull the drip tray forwards away from machine.
- 2) Keep pulling the drip tray slowly until the sticking point, lift gently and fully remove
- 3) After removing and cleaning, install the opposite order of removal.

check

✓ Do not pull with excessive force. Leftover water may splash out and cause an accident. Remove with caution

5. Side panel removal

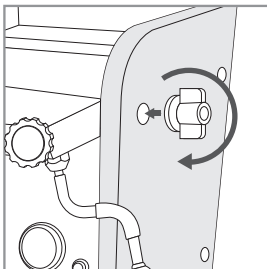

1) Using the included removal tool, remove the side panel bolt.

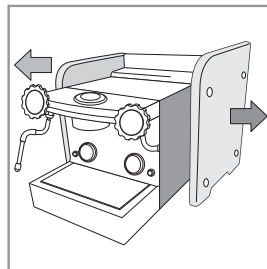

check

Not using the appropriate tool may cause damage to machine.

2) After removing every bolt, remove the side panel from the machine main body.

Q & A

Q. Steam comes out of the drip tray after the machine is first turned on.

A.This is a normal procedure of the vacuum breaker functioning and filling pressure inside the steam boiler.

Q.Power switch button keeps blinking.

A.Fill water in water tank. or Machine is still preheating to desired temperature.

Q.When first plugged in, the machine makes noise.

A.The noise is from the pump working to fill the boiler with water. Please check to see if there is water in the water tank.

Q.Pressure while extracting is not stable or pressure is different than usual.

A.Adjust grind size or use fresh coffee.

Q. Water leaks out of the portafilter during extraction.

A.There may be too much coffee or the portafilter may not be fully attached to the group head. Please tamp after dosing coffee up to the basket line and attach portafilter into grouphead fully until the portafilter can no longer move.

check

Every heating element is composed of over 3 different safety mechanisms and tools. Use without worry!

Some consumable parts must be replaced regularly throughout use.
(consumable parts: gasket, screen, basket, block spring, hot water and steam nozzle rubbering)

Controller user manual

1. **Twist the controller connection cap located at the rear of the machine.**

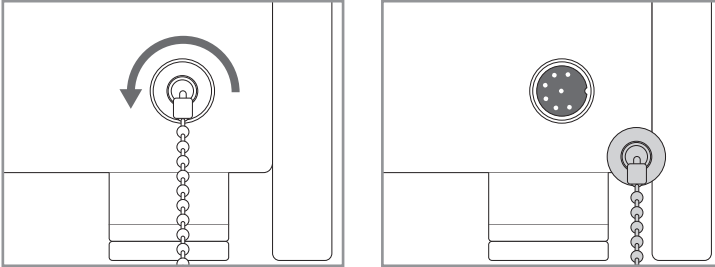

2. **Correctly line up the communication cord before plugging in.**

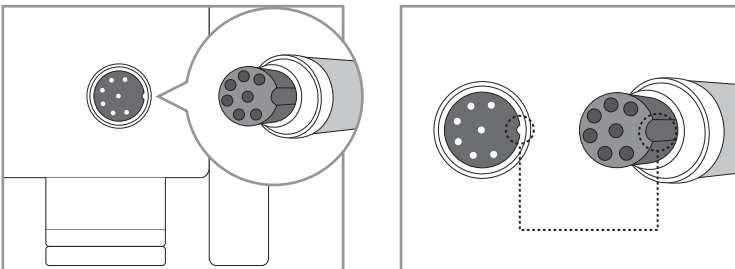

- ※ **Please turn the main power switch position to “OFF” before plugging in.**



WARNING

Plug in after matching up the notches. Communication cord must not be extended or tampered with. Damages may occur when using the controller on top of the machine or in high temperature environments.

El Rocio

Controller user manual

3. Once plugged into the machine, turn the securing lock nut to fix the position and turn the power on by turning the main power switch located at the bottom right position to "ON"

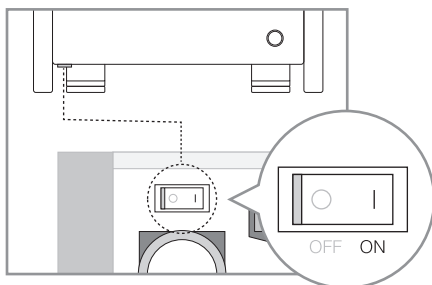
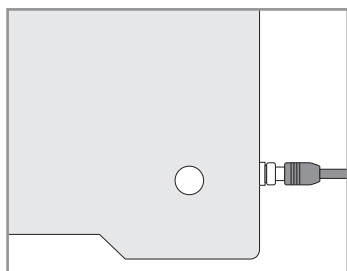

Precautions

- Keep sharp / flammable/combustible objects safe and away.
 - Do not place heavy objects on top of the controller.
 - Do not forcefully twist or apply force to the controller dial part.
 - Do not keep the controller on top of the machine.
- Use on a flat surface.
- When not using the controller, switch the main power switch to "OFF" and then disconnect the cable.

Controller LCD

1. Controller start display

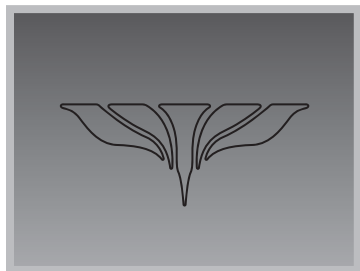

※ Please read the precautions before powering on.



warning

※ Damages may occur when a sharp object is used to operate the LCD display.

※ After purchase, fill the machine service tank with water, turn the machine on to fill the boiler with water, and then follow the controller installation guide

2. LCD home display

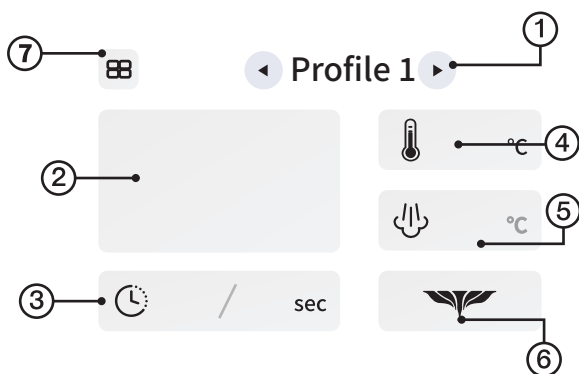

- ① Mode settings
- ② Current profile display
- ③ Extraction time / total extraction time
- ④ Current extraction temperature
- ⑤ Current steam temperature
- ⑥ Extraction button
- ⑦ Settings

El Rocio

Controller LCD

3. Settings

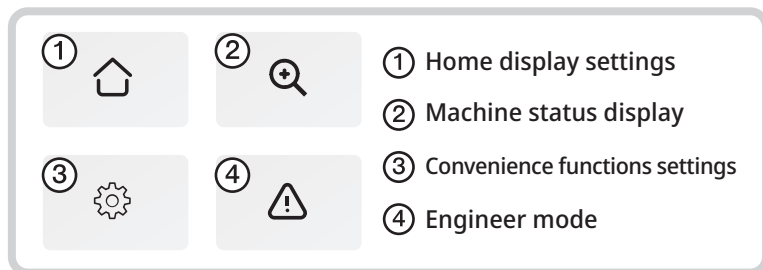

3-1. Machine status display

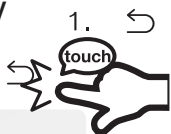
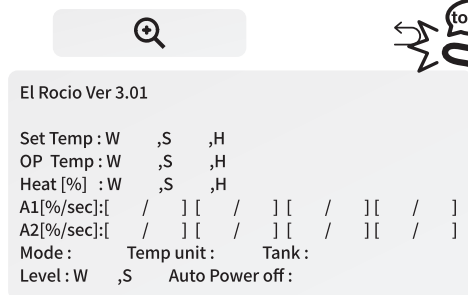

Click arrow to return to settings



Set Temp : W Extraction boiler temperature
: S steam boiler temperature
: H Group head temperature

OP Temp : W Extraction boiler temperature
: S steam boiler temperature
: H Group head temperature

Heat[%] heater output

A1 Details by section

A2 Details by section

In the following cases, please contact an engineer

3-2. Convenience functions settings

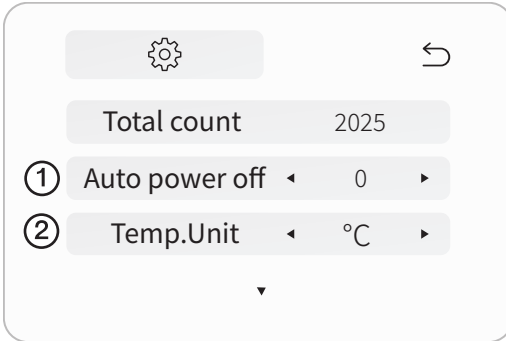

① Auto off time setting

Machine will turn off automatically after a set period of time.

② Temperature unit change

'F' 'C can be set to a convenient unit

③ When using the auto clean mode, backflush cycle count can be adjusted

► Read p.26

④ Smart plug usage / non-usage selection

⑤ ◀ After completing the settings, click the previous button

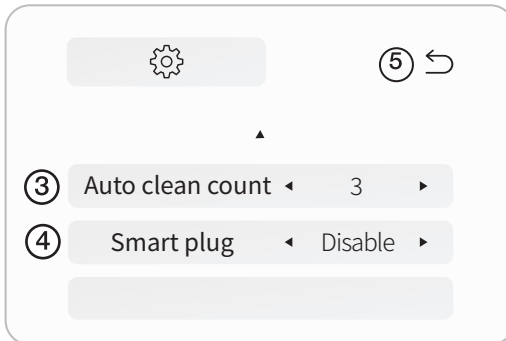

3-3. Engineer mode



Please consult a certified engineer before entering the engineer mode. This is the input window for an in-house program data. AS and program setting data can be viewed here.

*El Rocio is not responsible for damages or injuries resulted from unauthorized tampering.

El Rocio

Controller LCD

4. Profile Settings

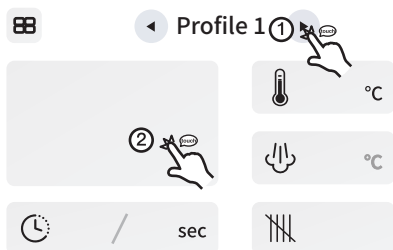

1. Select the profile to make changes to.
2. Select the current profile window then return to main screen.

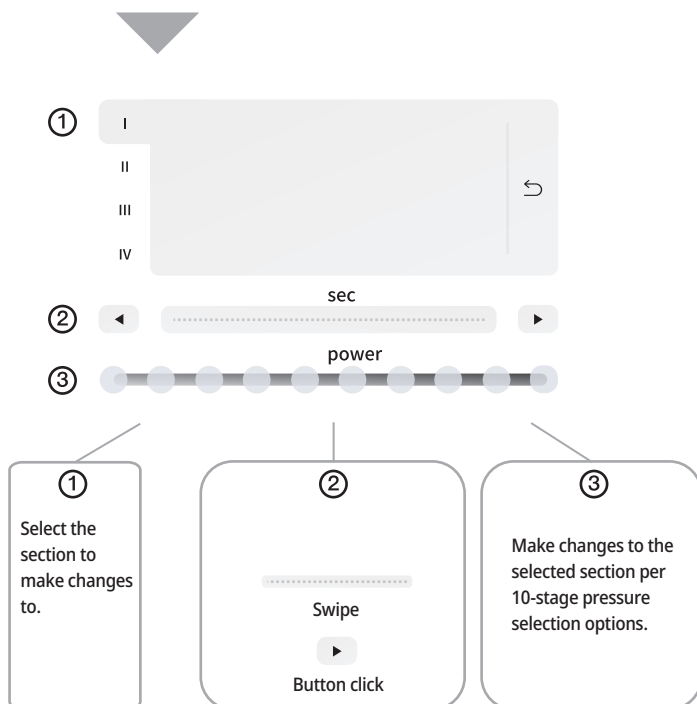

3. ↩ Click after settings are finalized

5. Dial mode

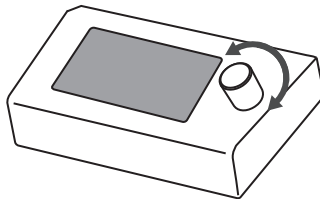
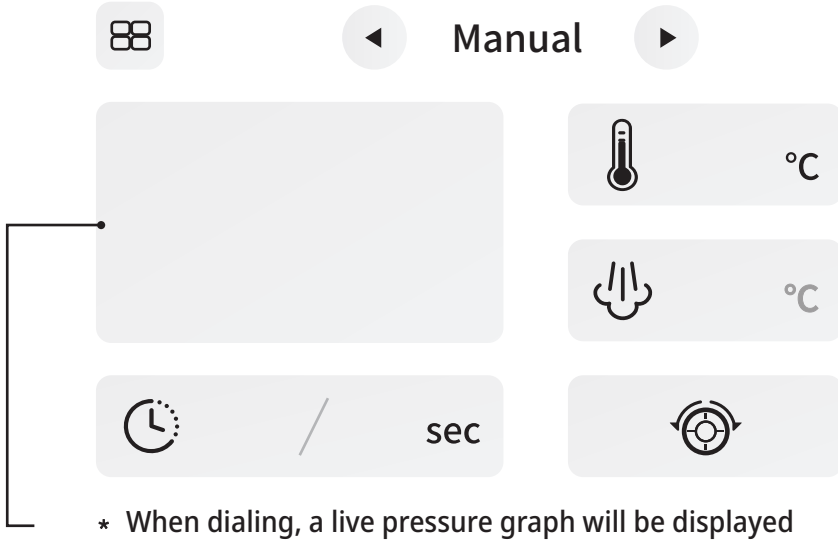

※ when in manual mode, the main extraction button becomes disabled.

- ① Pressure can be changed mid-extraction once manual pressure profiling mode is selected.
- ② After extraction is complete, please turn the dial all the way counterclockwise until it makes a click noise.

El Rocio

Controller LCD

6. Auto clean mode

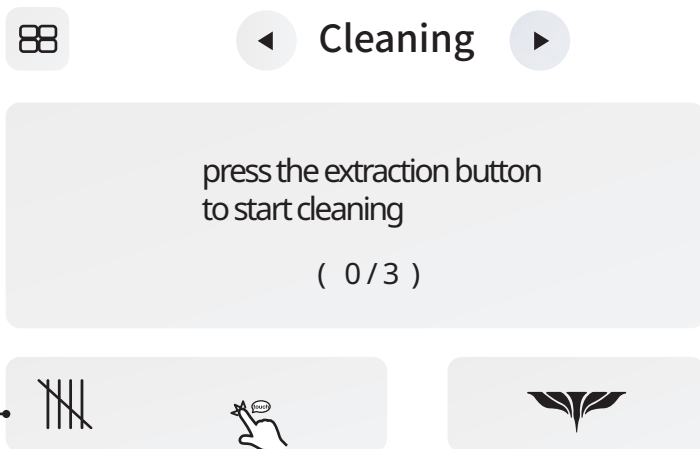

- ① 23p. By changing the auto clean count, the backflushing count can be set up.
- ② Start clean mode by clicking the El Rocio button.
- ③ When count is clicked, reset question window can be activated.
- ④ Using the count reset function, the cleaning period can be checked thoroughly.

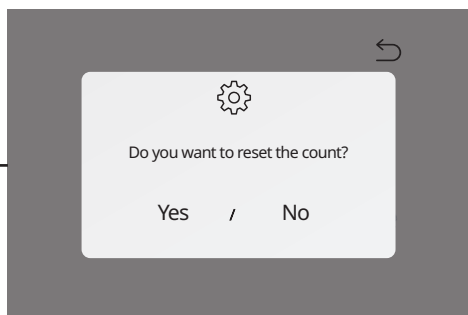

7. Temperature setting

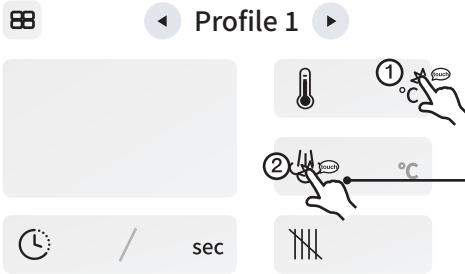

1. Select temperature display, then change displays

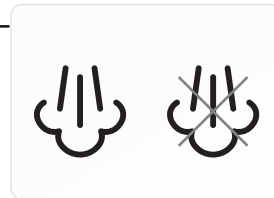

Steam on/ off setting possible

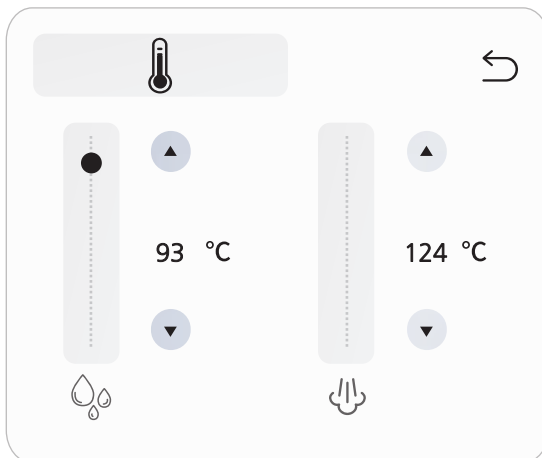

2. Temperature can be set by swiping the scroll bar or by using the up down buttons.

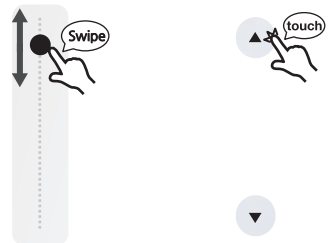

3. ↶ Return to the previous menu once set up.

El Rocio

Controller LCD

8. Additional features

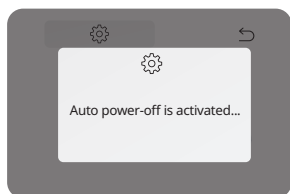

Auto off notification function
Pre-configured auto off function will initiate soon.

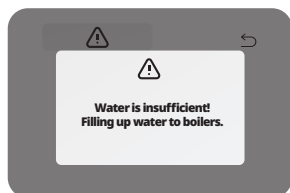

Water add notification function
Steam boiler / extraction boiler / water reservoir

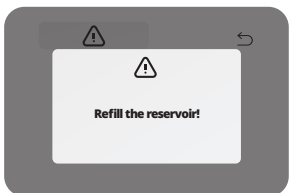

please only fill water up to fill line.

Q & A

Q.Controller power is unstable or does not get recognized.

A.Check connection condition and make sure it is properly connected.

Q.Some functions do not work properly.

A.Receive A/S from El Rocio.

Q.Machine and controller are not powering on.

A.Check the double power button status or the power's fuse condition.

(Make sure power is checked with everything separated)

If still no power, receive A/S.

MEMO



EL ROCIO
e s p r e s s o m a c h i n e

www.elrocio.co.kr